

11 INSTRUMENTS



TP Orthodontics, Inc.
tportho.com
cosmeticbraces.com

INSTRUMENTS

Chairside

- Straight Shooter® Ligature Gun
- M-D Reducer
- Divider
- Dontrix Gauge
- Bonding Forceps
- Bracket Placing Forceps
- Debonding Burs
- Bite Stick
- Band Pusher
- Expansion Swivel Key

Pliers

- Power Crimping
- Crimpable Hook Placement
- Light Wire without Grooves
- Light Wire with Three Grooves
- Safety Distal End Cutter
- Standard Ligature Cutter
- Posterior Band Removing
- Weingart
- Arch Contouring—Smooth
- Sep-A-Rings® Placement

Instruments

- Mosquito Hemostat
- Mathieu Style Tying and Elastomeric
- Click-It Forceps

Laboratory Tools

- Wax Spatula
- Cement Spatulas
- Plaster Spatula
- Plaster Knife

Instrument Shield

Straight Shooter® Ligature Gun

The Straight Shooter ligature gun provides a safe, convenient, hygienic means of applying elastomeric ligatures to edgewise brackets. Eliminates soft tissue damage that can be caused by hemostats or other instruments or by broken or slipped ligatures.

Two sizes are available. The mini bracket shooter is for mini and single-wing brackets and the twin bracket shooter is for standard, twin-size brackets.

High performance, thermoplastic material is very strong and can withstand autoclaving and heat sterilization.

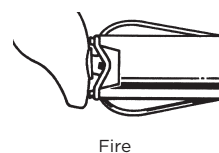
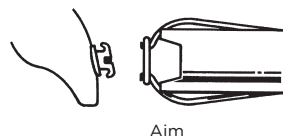
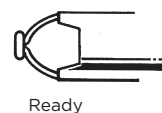

Straight Shooter Ligature Guns

- 100-357** Twin Bracket Straight Shooter
- 100-359** Mini Bracket Straight Shooter

Replacement Materials

- 100-363** Mini Bracket Plunger Kit - plunger and 4 wire fingers
- 100-364** Straight Shooter Assembly / Disassembly Tool
- 100-365** Twin Bracket Plunger Kit - plunger and 4 wire fingers

M-D Reducer

Removes interproximal tooth mass from flat or curved surfaces. May be used to produce additional intra-arch space, open points, recontour restorations or remove overhanging fillings. Available with frame and stainless steel cutter blades with a diamond coating.

- 100-701** M-D Reducer Kit - Contains 1 anterior frame, 5 fine and 5 coarse blades - double-sided only

Replacement Materials

- 100-700** Frame
- 100-703** Fine Blades - double-sided, 10
- 100-704** Coarse Blades - double-sided, 10
- 100-705** Fine Blades - single-sided, 10
- 100-706** Coarse Blades - single-sided, 10
- 100-707** Fine Blades, Wide - single-sided, 10
- 100-708** Coarse Blades, Wide - single-sided, 10

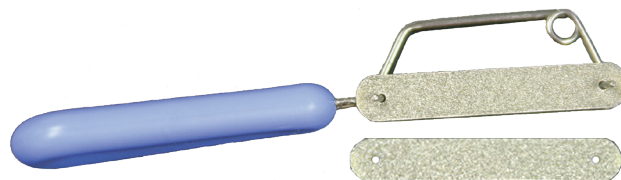

Divider

Measures 14.4 cm (5.5"), has a friction hinge and fixed needle points. Matte nickel finish resists stains and tarnishing.

- 100-331** Divider



Dontrix Orthodontic Stress and Tension Gauge

Precisely determines the exact force and/or pressure of elastics, springs and wires. Slip fork over archwire to determine the force of a coil spring. Notch may be used to push archwire or finger spring to its seated position. Use hooked end to draw elastic to its working position.

100-675 Dontrix Gauge, 112 g (4 oz.)

100-676 Dontrix Gauge, 448 g (16 oz.)



Bonding Forceps

Self-locking forceps with thin tips grasp brackets securely. Handle tip for minor bracket adjustment. Forceps have the Never-Mar finish.

100-157 Bonding Forceps



Bracket Placing Forceps

Slim, curved tips permit excellent field of vision and simplify placement of steel ligatures and elastomeric.

100-136 Bracket Placing Forceps



Debonding Burs

Tapered dome carbide burs with 1.2mm (.047") diameter remove excess adhesive after debonding. Friction grip and latch lock shanks are compatible with contra-angle handpieces. The 100-119 bur is used with a straight handpiece.

- 100-119** Straight Handpiece Debonding Bur
- 100-121** Contra-Angle Handpiece, Friction Grip Bur
- 100-122** Contra-Angle Handpiece, Latch Lock Bur
Package of 1



Heat Resistant Bite Stick

Bite stick withstands temperatures to 210°C (410°F), making it autoclavable or safe for rapid cycle dry heat units. Not recommended for use with cassettes.

- 100-460** Heat Resistant Bite Stick



Band Pusher

Hollow handle, light and sturdy. Serrated tip on four sides for accurate and slip-resistant positioning while banding.

- 100-179** Band Pusher
Package of 1



Expansion Swivel Key

Expansion swivel key is a safe and easy tool for patients to adjust their fixed rapid palatal expansion appliances. Plastic handle measures 11.4 cm (4.5").

- 100-209** Expansion Swivel Key
Package of 3

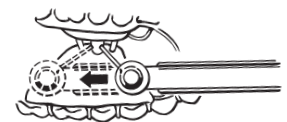
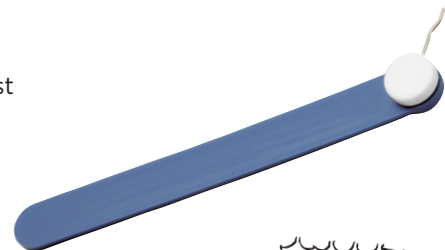

Patented

Never-Mar Instruments

Never-Mar instruments have a unique brushed finish that provides a surface to keep instruments looking new longer and eliminates glare. Never-Mar protects against fingerprints and minor scratches and is available at no additional charge. The catalog indicates which instruments are made with the Never-Mar finish.

Power Crimping Pliers

Power crimping pliers are an improved version of our original crimpable hook pliers. This new plier features ergonomic handles that are wider and longer, enabling the orthodontist to exert up to twice as much force when placing TPO crimpable hooks and ribbed crimpable hooks onto archwires. Pliers have the Never-Mar finish.

100-192 Power Crimping Pliers



Crimpable Hook Placement Pliers

Crimpable hook pliers feature a V-notch in the beak that greatly assists holding and compressing our small crimpable hooks. Pliers have the Never-Mar finish.

100-172 Crimpable Hook Placement Pliers



Light Wire Pliers without Grooves

Smooth-tipped pliers bend archwires from 0.30mm (.012") to 0.56mm (.022"). Flat "anvil" area ahead of box joint hinge permits wire straightening and increases grip on wire. Pliers have Never-Mar finish.

100-130P Light Wire Pliers without Grooves

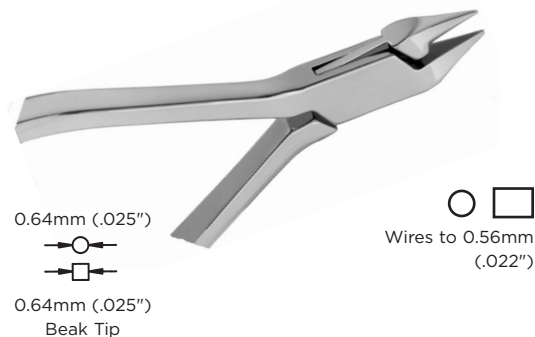

Light Wire Pliers with Three Grooves

The Light Wire Pliers with Three Grooves feature three grooves at the tip with a loop closing groove at the base of the beak. Bends round, square and rectangular wires up to 0.020".

100-125 Light Wire Pliers with Three Grooves



Safety Distal End Cutter Pliers

Designed to shear cut archwires and securely hold distal end of wire. Pliers cut within 0.5mm (.0197") of buccal tube. Pliers have the Never-Mar finish.

100-138P Safety Distal End Cutter Pliers



Standard Ligature Cutter Pliers

Sharp edges are effective for all soft wires, pins and elastics up to 0.41mm (.016"). Pliers have the Never-Mar finish.

100-140P Standard Ligature Cutter Pliers



Posterior Band Removing Pliers

Stainless steel with medium length jaw and inserted tip. Pliers have the Never-Mar finish.

100-141P Posterior Band Removing Pliers

100-161 Replacement Tip



Weingart Pliers

Most popular utility pliers with long-wearing tips. Pliers have the Never-Mar finish.

100-149P Weingart Pliers



Arch Contouring Pliers—Smooth

Designed for creating proper contour in anterior segment of archwire. Degree of curve can be varied by regulating position of wire in beaks. Pliers have the Never-Mar finish.

100-128 Arch Contouring Pliers—Smooth



○ □
Wires to 0.56mm
(.022")

Sep-A-Rings® Placing Pliers

Designed for placing TPO Sep-A-Rings, pliers limit excessive expansion which could cause rings to break. Rounded beaks protect patient and positively hold rings during placement. May be used with large or small Sep-A-Rings.

100-135 Sep-A-Rings Placing Pliers



Mosquito Hemostat Straight Tip

Straight 11.4 cm (4.5") thin tip is serrated to provide tight grip for ligating elastomeric ligatures. Click-lock handles.

100-132 Mosquito Hemostat



Mathieu Style Tying and Elastomeric Pliers

Stainless steel pliers with and without carbide inserted tips and self-locking handles.

- 100-146** Tying and Elastomeric Pliers with Tip Insert
- 100-185** Tying and Elastomeric Pliers without Tip Insert



Click-It® Forceps

The Click-It Forceps Assembly is designed exclusively for Click-It Self-Ligating Aesthetic Brackets and includes the frame, release tips and insertion tip.

The release tips are design to easily open/close the Click-It bracket. The insertion tips assist with wire engagement in difficult to reach posterior segments.

The Click-It Angled Forceps Assembly is designed primarily for the posterior brackets so the forceps can be most effective with the tips being oriented parallel to the labial surface of the tooth. They can also be used on anterior teeth, eliminating the need for two forceps, as long as the tips are being applied parallel to the labial surface of the tooth.

The angled forceps include a self-aligning stop feature to ensure the tips remain in the optimum position for bracket activation and to help prevent rapid tip wear.

- 100-198** Click-It Forceps Assembly
Each
- 100-098** Click-It Forceps Assembly, Angled, includes release tips
Each
- 100-199** Click-It Release Tips (5 Left, 5 Right)
Package of 10
- 100-200** Click-It Insertion Tips
Package of 5
- 100-099** Click-It Release Tips, Angled, 45° (5 Left, 5 Right)
Package of 10



Wax Spatula

Wax Spatula No. 7. stainless steel, overall length 15.8 cm (6.25").

100-320 Wax Spatula



Cement Spatulas

Thin, flexible, stainless steel blades.

100-342 Cement Spatula, 3.8 cm (1.5") Blade

100-343 Cement Spatula, 5.1 cm (2") Blade



Plaster Spatula

Perfectly shaped to fit contour of plaster bowls for ease in mixing. Stainless steel blade is 8.9 x 3.8 cm (3.5" x 1.5"). Plastic handle.

100-310 Plaster Spatula



Plaster Knife

Thin, sharp steel blade is 4.1 cm (1.625"), overall length 13.7 cm (5.375"). Wooden handle.

100-300 Plaster Knife



Instrument Shield

Use prior to heat sterilization to lubricate and protect instruments. Contains a special additive that dissolves organic debris build-up in plier box joints.

Helps extend life of instruments when used after every cleaning. Immerse clean instruments into solution for 30 to 45 seconds. Remove instruments and allow excess solution to drain. Instruments are then ready for sterilization.

100-878 Instrument Shield, 3.8 L (1 gallon)

100-879 Instrument Shield, .95 L (1 quart)

